

Positron Emission Tomography (PET) seen in a new light

Positron Emission Tomography (PET) uses the principle of the so called annihilation of positrons with electrons while gamma-photons [γ] are released. These gamma-photons [γ] can be detected with a scanner giving information about location and appearance of specific organs.

The necessary positrons can be given by radioactive decay of certain atoms like Carbon-11 and Oxygen-15.

Current insights

The case Study "Positron Emission Tomography (Last updated 11:48, 12 Jun 2016)" gives the following description:

https://chem.libretexts.org/Core/Physical_and_Theoretical_Chemistry/Nuclear_Chemistry/Applications_of_Nuclear_Chemistry/Applications_of_Radiation_in_Biology_and_Medicine/Case_Study%3A_Positron_Emission_Tomography

The emission of a positron is represented by:



This shows that the positron (represented here by e^+) speeds out of the nucleus while the neutron stays inside the nucleus. Consider the following nuclear reaction that is common in PET scans of the brain where carbon-11 is used as the tracer molecule.

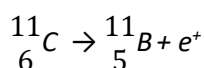

Notice that in this example of positron emission, the nuclide changes into a different element and as it gives off a positron particle, the atomic number is lowered by one, but the mass of the new element stays the same as the carbon that has decayed.

Wikipedia (https://en.wikipedia.org/wiki/Isotopes_of_carbon) says about this subject:

Carbon-11 or C^{11} is a radioactive isotope of carbon that decays to boron-11. This decay mainly occurs due to positron emission; however, around 0.19–0.23% of the time, it is a result of electron capture. It has a half-life of 20 minutes.

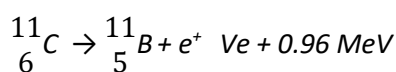

Carbon-11 is commonly used as a radioisotope for the radioactive labeling of molecules in positron emission tomography. Among the many molecules used in this context is the radioligand [${}^{11}\text{C}$]DASB (labeled with carbon-11).

Decay of protons

Positron Emission Tomography (PET) uses –as assumed in the published articles (Case Study: Positron Emission Tomography (Last updated 11:48, 12 Jun 2016, Wikipedia)– the transition of protons to neutrons.

On Wikipedia (https://en.wikipedia.org/wiki/Proton_decay) you can find that there is currently no experimental evidence that proton decay occurs when a proton is on its own.

For neutron you can find on Wikipedia that is the decay of the free neutron is possible.
https://en.wikipedia.org/wiki/Free_neutron_decay

Wikipedia: $n^0 \rightarrow p^+ + e^- + \nu_e$
 ν_e hierin is circa 0.78 MeV ($1,25 \cdot 10^{-13}$ Joule), $1 \text{ eV} \approx 1,60 \cdot 10^{-19}$ Joule.

There are claims of the transition of protons to neutrons within the decay of more complex particles. In many cases there is a relation with Positron Emission Tomography. Relevant is this case is the decay of C^{11} en O^{15} .

Consideration

According to our theory the transition of a solitary proton to a neutron is complex and not to be expected. The organization of matter needed in a reverse reaction by with a proton changes into a neutron (following our equation) does not lead (in our view) to the forming of gamma-photons [γ].

The equations are once more given:

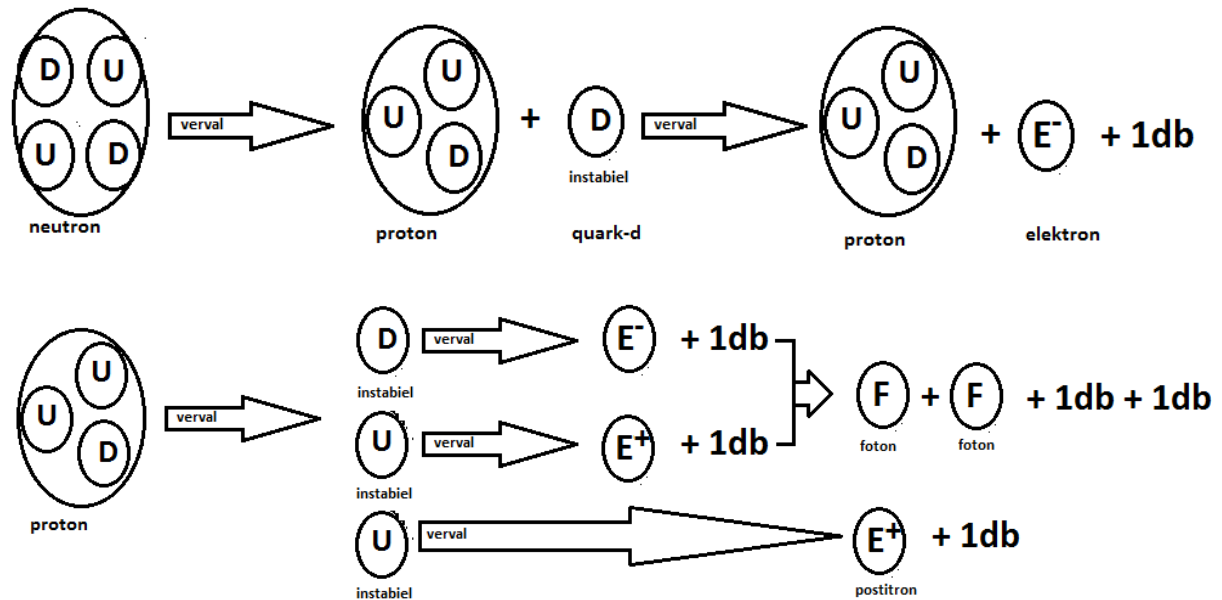

For the db (dimensional basic) the following symbol will be used: λ.

According to our model only the decay of a proton can lead instantly to the appearance of gamma-photons [γ].

Using our theory we suggest different mechanisms for Positron Emission Tomography (PET). First we give a suggestion for the decay of Carbon-11. Then we give a suggestion for the decay of Oxygen-15.

Carbon-11

Carbon-11 is an isotope of carbon, frequently used in positron emission tomography, or PET imaging. It has 6 protons, 5 neutrons, and 6 electrons. It has a half-life of 20 minutes*.
https://en.wikipedia.org/wiki/Isotopes_of_carbon#Carbon-11

Decay C¹¹ (2 atoms)

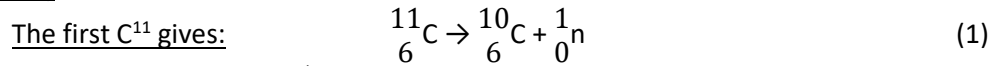

C¹⁰ is not stable/half-life 20 sec*, ${}^1_0\text{n}$ is used in (3).

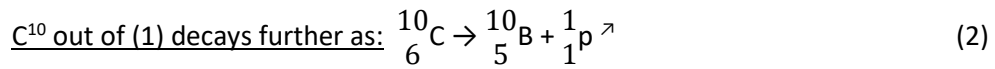

B¹⁰ is stable*, possibility: [p → 2 γ + 3 μ + e⁺], in that case the proton will not be seen, the e⁺ will follow (4).

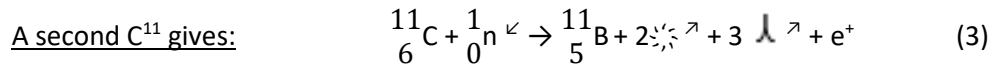

In (3): [p → 2 γ + 3 μ + e⁺], ${}^1_0\text{n}$ is delivered by (1), B¹¹ is stable*.

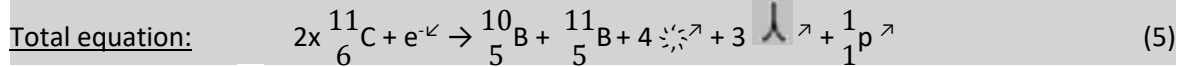
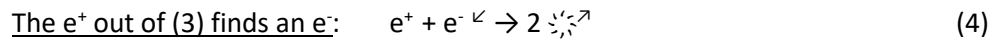

Possibility: [p → 2 γ + 3 μ + e⁺], in that case the proton will not be seen, the e⁺ will follow (4).

Oxygen-15

Oxygen-15 is an isotope of oxygen and is also frequently used in positron emission tomography, or PET imaging. It has 8 protons, 7 neutrons, and 8 electrons. It has a half-life of 122 seconds.

(https://en.wikipedia.org/wiki/Isotopes_of_oxygen)

Decay O¹⁵ (2 atoms)

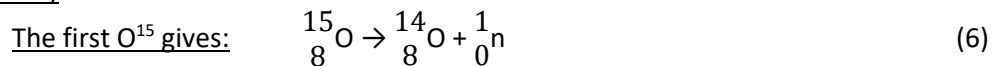

O¹⁴ is not stable/half-life 70 sec*, ${}^1_0\text{n}$ is used in (8).

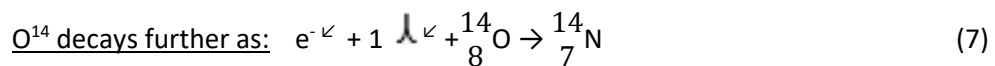

In (7) [e⁻ + 1 μ + p → n], N¹⁴ is stable*

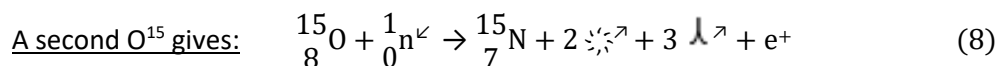

In (8): [p → 2 γ + 3 μ + e⁺], ${}^1_0\text{n}$ is delivered by (6), N¹⁵ is stable*

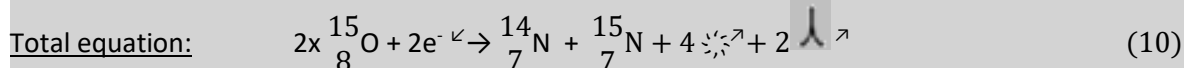
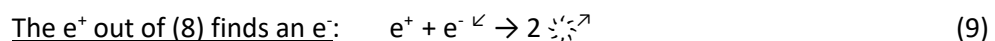

The given half-lives* are taken from: <http://periodictable.com/Isotopes/007.15/index2.p.full.prod.html>

Jelle Ebel van der Schoot, Gerhard Jan Smit, Job Jelle van der Schoot, 20 february 2017, Nijmegen

www.dbphysics.org